

Heft vom Mengenprofi

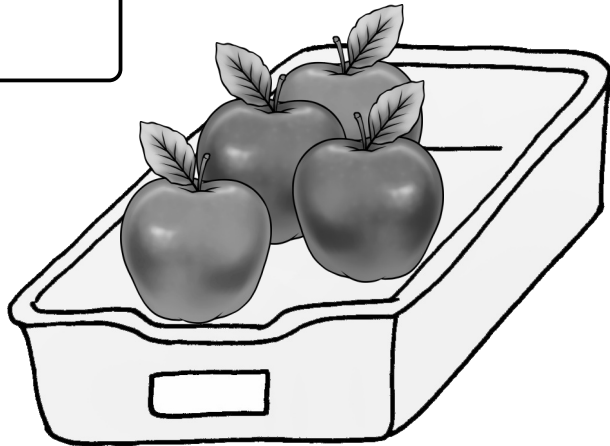
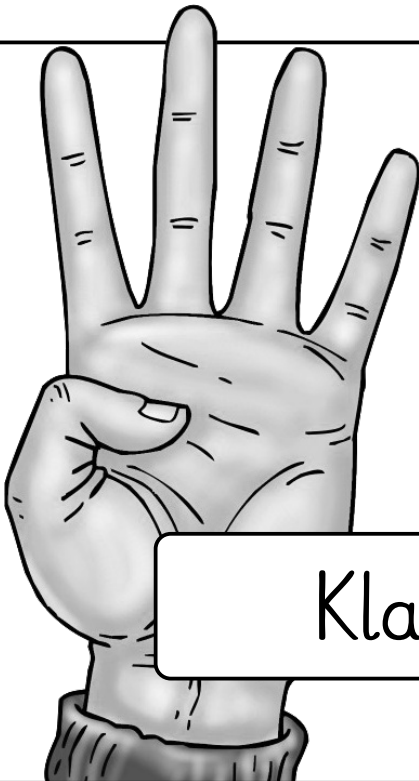
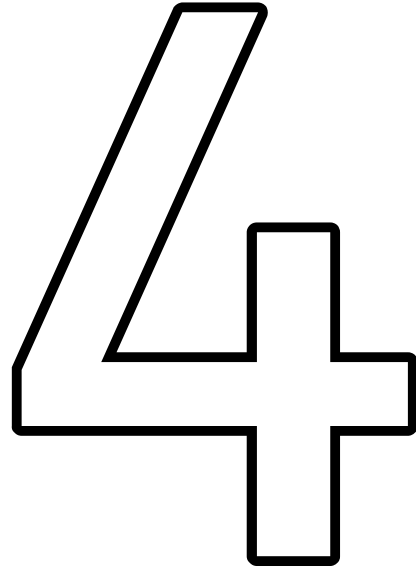

Klasse 1

In diesem Heft kannst du lernen, schnell Mengen zu erkennen.
Arbeite sauber und ordentlich!
Das Heft musst du bei der Lehrerin abgeben.

Die 0 schreiben

Spure zuerst die große Null fünfmal mit verschiedenen Farben nach!
Schreibe dann die Null, zuerst mit Hilfe der Punkte und dann ganz alleine!

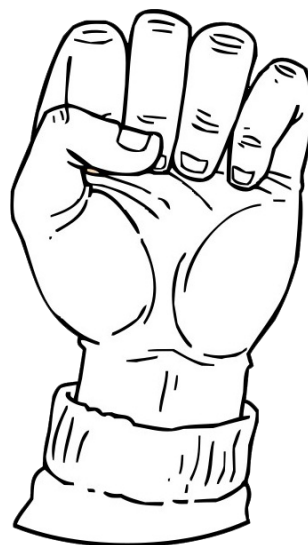
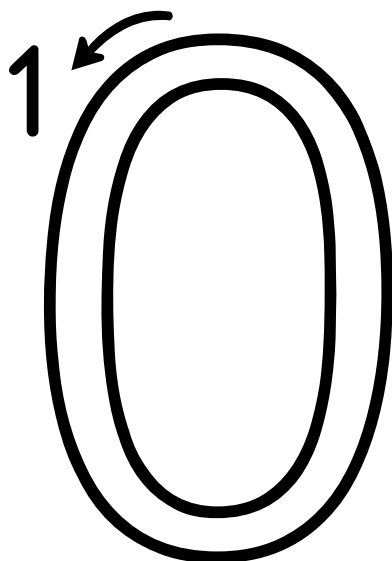

0	0	0	0	0	0	0	0
0	0	0	0				

0	0	0	0	0	0	0	0	0	0	0
0	0	0	0	0	0	0				
0	0	0	0	0	0					
0	0	0								

Hier hat jemand die Nullen angeknabbert. Repariere sie mit deinem Bleistift!

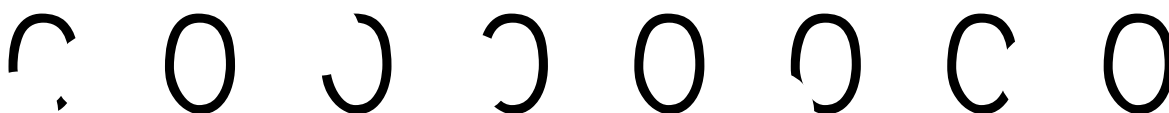

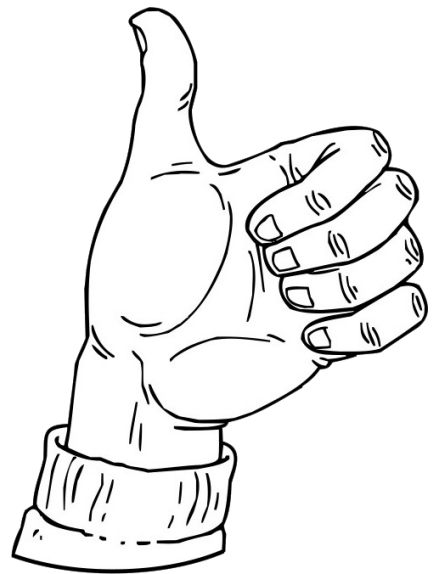
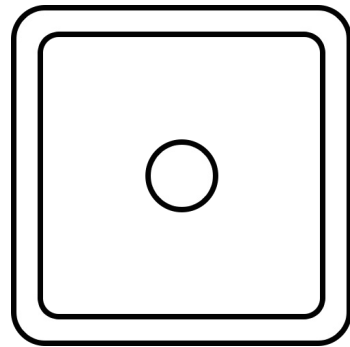
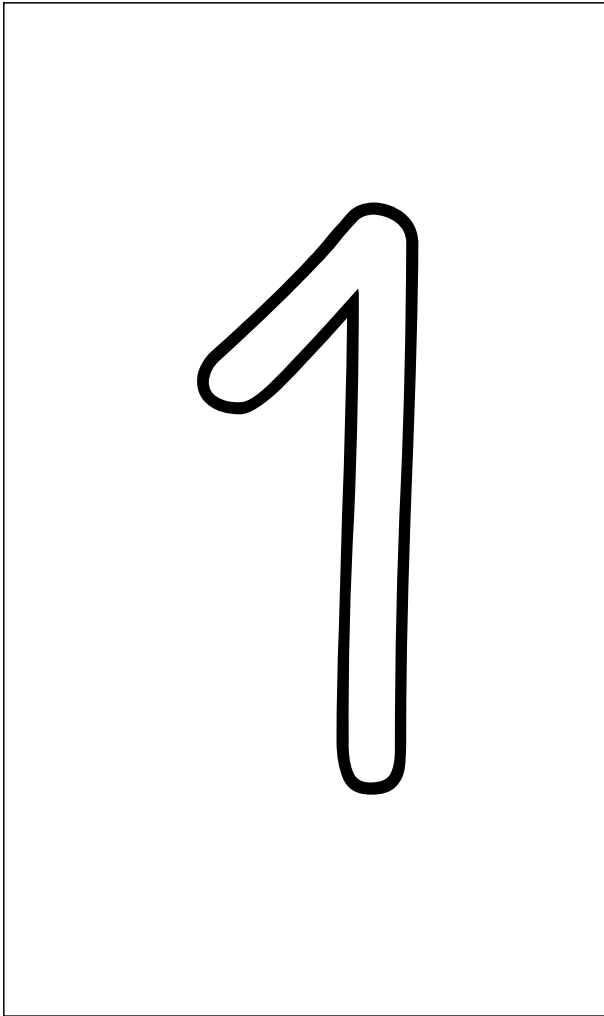

1 oder mehr? Male alle Bilder aus, die 1 Ding zeigen!

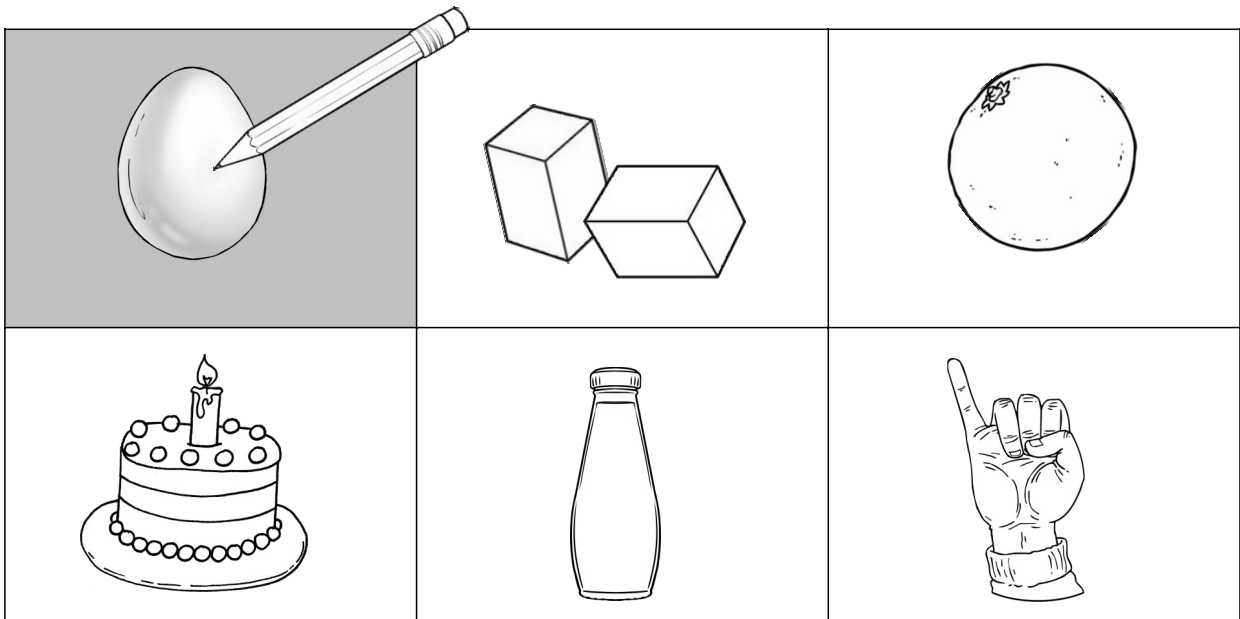

Die 1 schreiben

Spure zuerst die großen Einsen fünfmal mit verschiedenen Farben nach!
Schreibe dann die Zahlen, zuerst mit Hilfe der Punkte und dann ganz alleine!

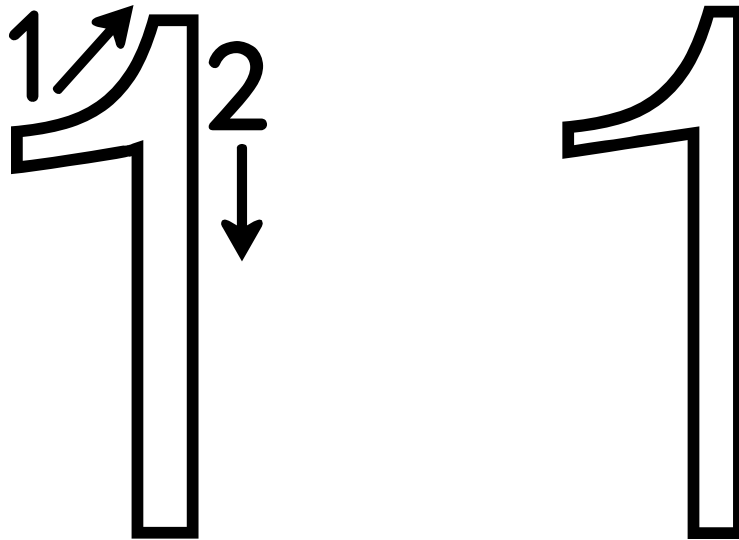

1	1	1	1	1	1	1	1
1	1						

1	1	1	1	1	1	1	1	1	1	1	1
1	1	1	1	1	1	1	1	1			
0	1	0	1								
1	0	1	0								

Hier hat jemand die Einsen angeknabbert.
Repariere sie mit deinem Bleistift!

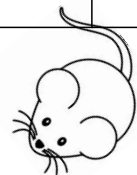

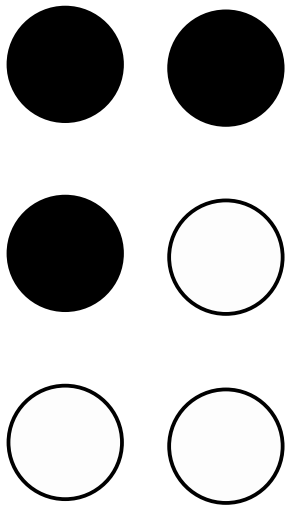
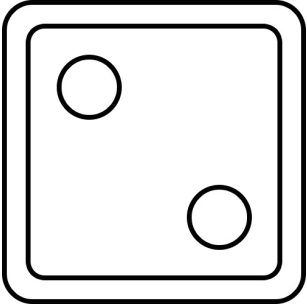
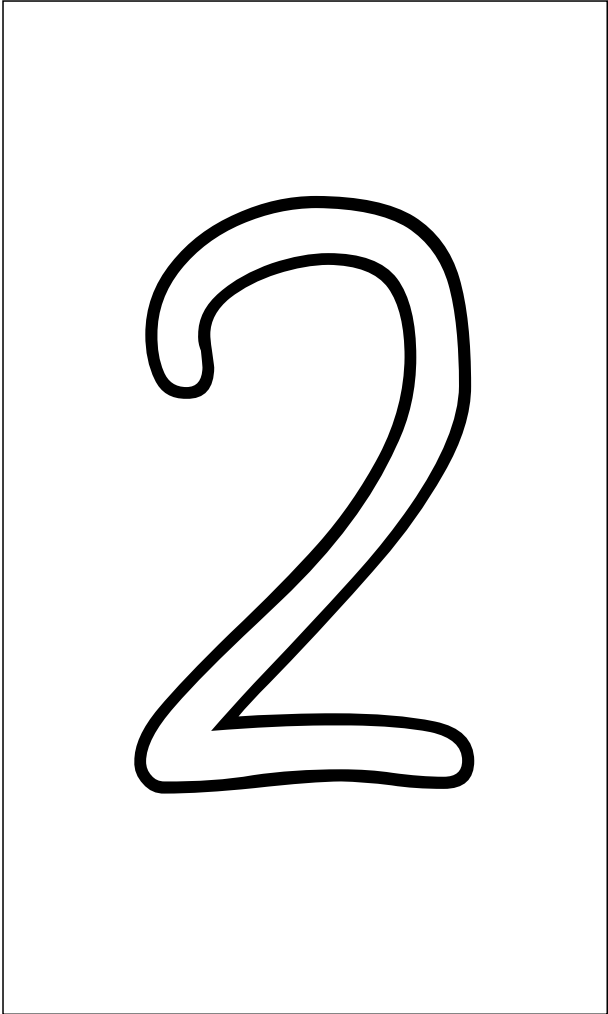

	+	
	+	
	+	

Die 2 schreiben

Spure zuerst die großen Zweien fünfmal mit verschiedenen Farben nach!
 Schreibe dann die Zahlen, zuerst mit Hilfe der Punkte und dann ganz alleine!

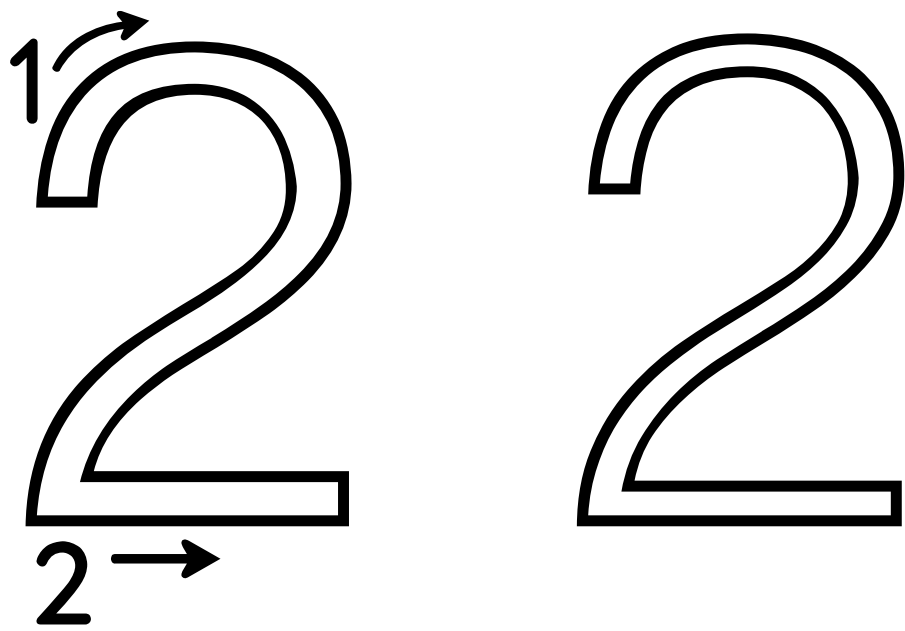

2	2	2	2	2	2	2	2
2	2						

2	2	2	2	2	2	2	2	2	2	2	2
2	2	2	2	2	2	2	2	2	2	2	2
1	2	1	2								
2	1	2	1								

Hier hat jemand die Zweien angeknabbert.
 Repariere sie mit deinem Bleistift!

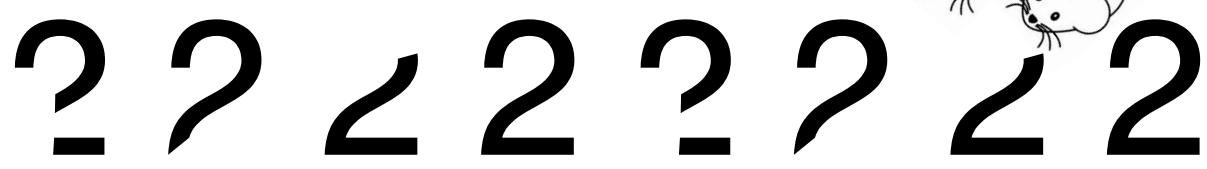
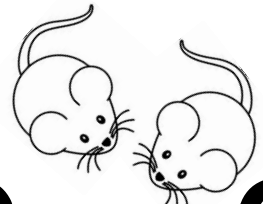

Immer 2

Kreise immer 2 Sterne ein! Verwende für jeden Kreis eine andere Farbe!

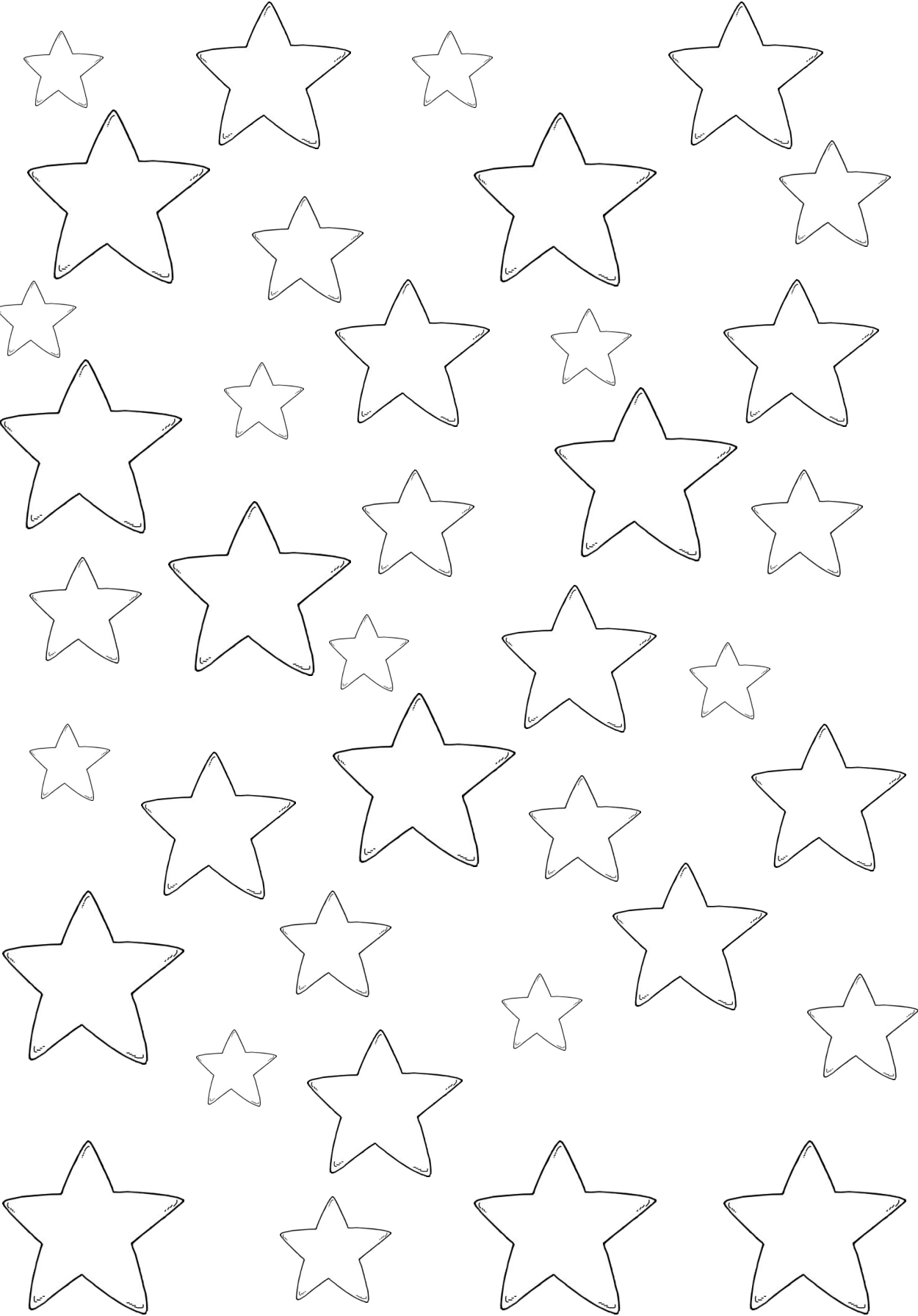

1 oder 2 Monster? Schreibe!

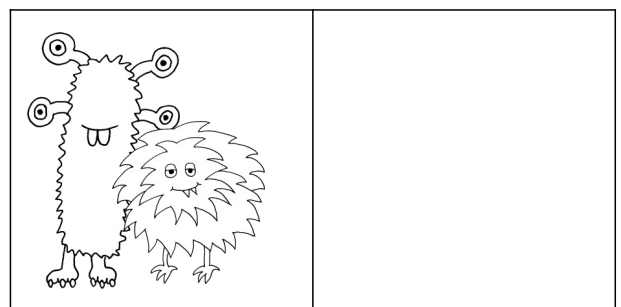
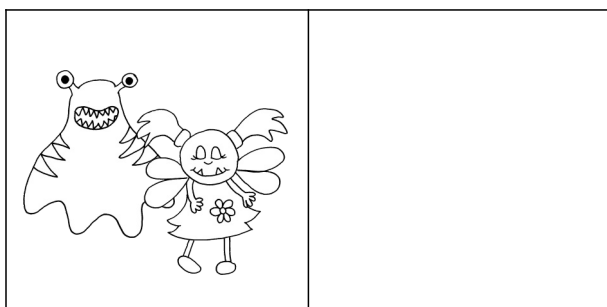
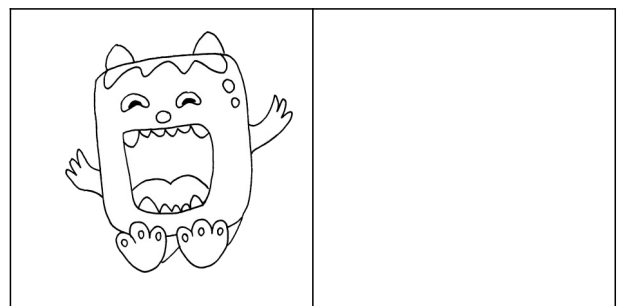
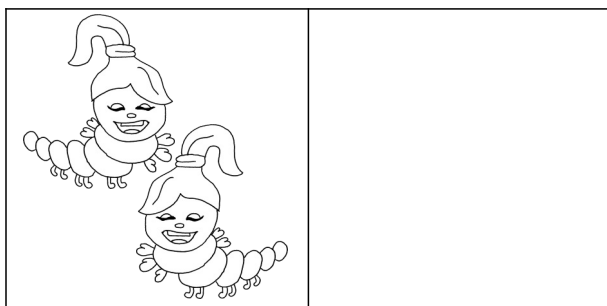
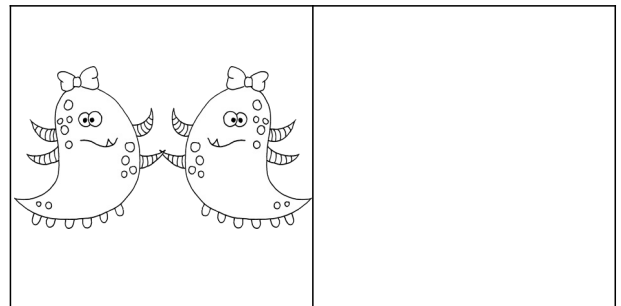
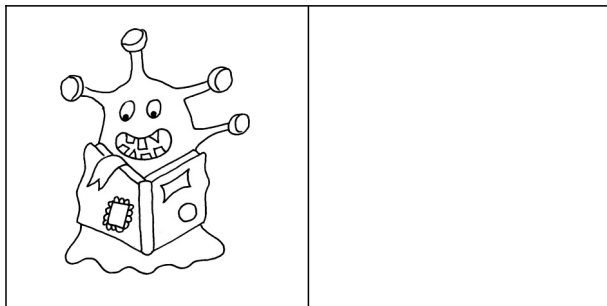
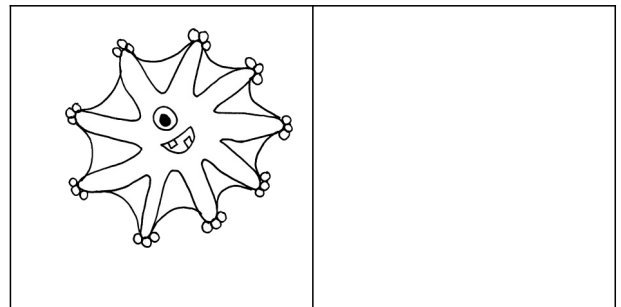
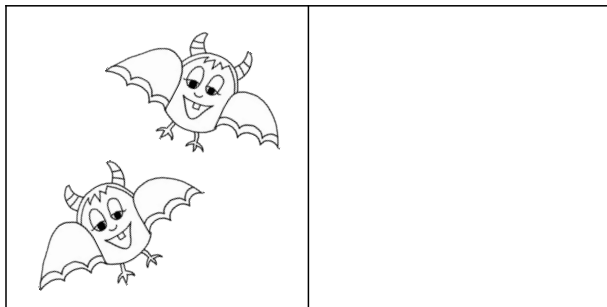
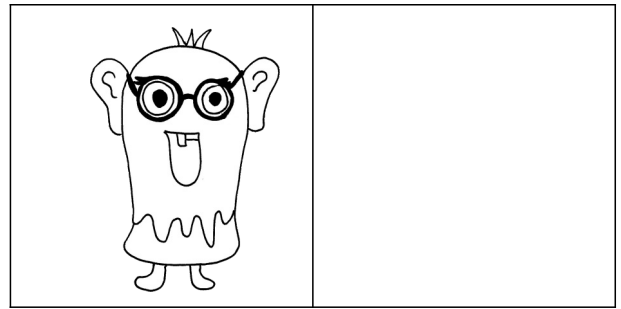
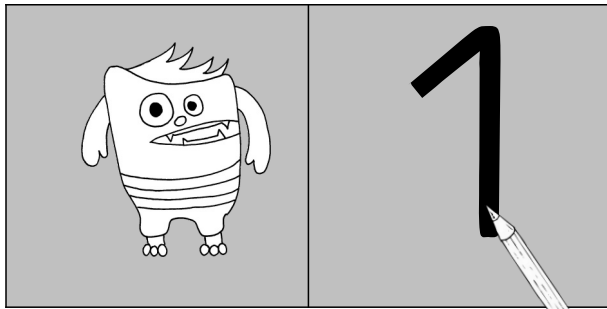

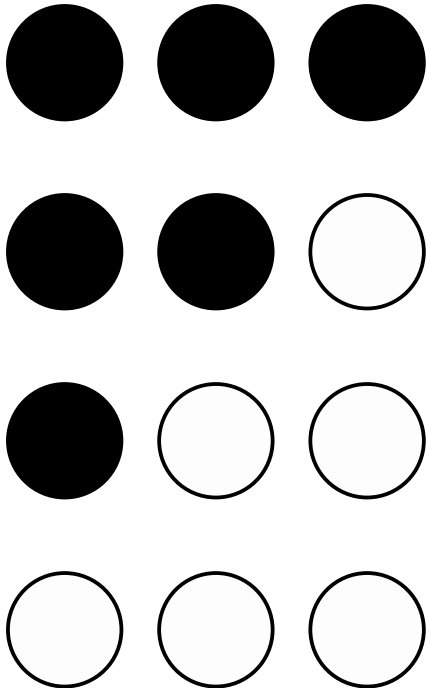
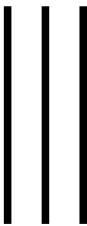
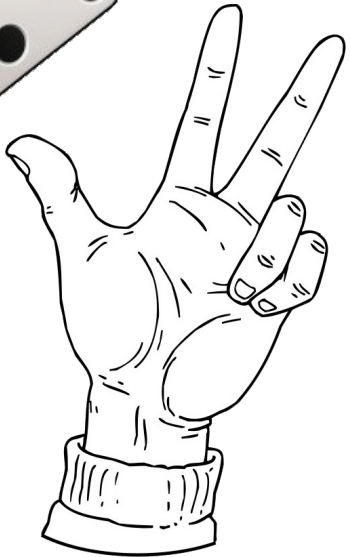
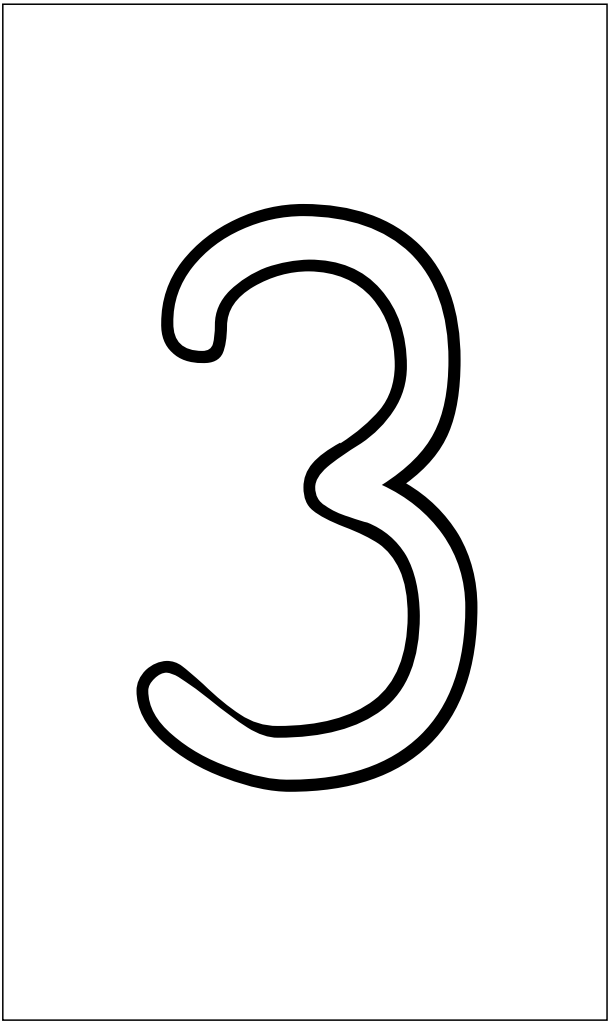

	+	
	+	
	+	
	+	

Die 3 schreiben

Spure zuerst die großen Dreien fünfmal mit verschiedenen Farben nach!
Schreibe dann die Zahlen, zuerst mit Hilfe der Punkte und dann ganz alleine!

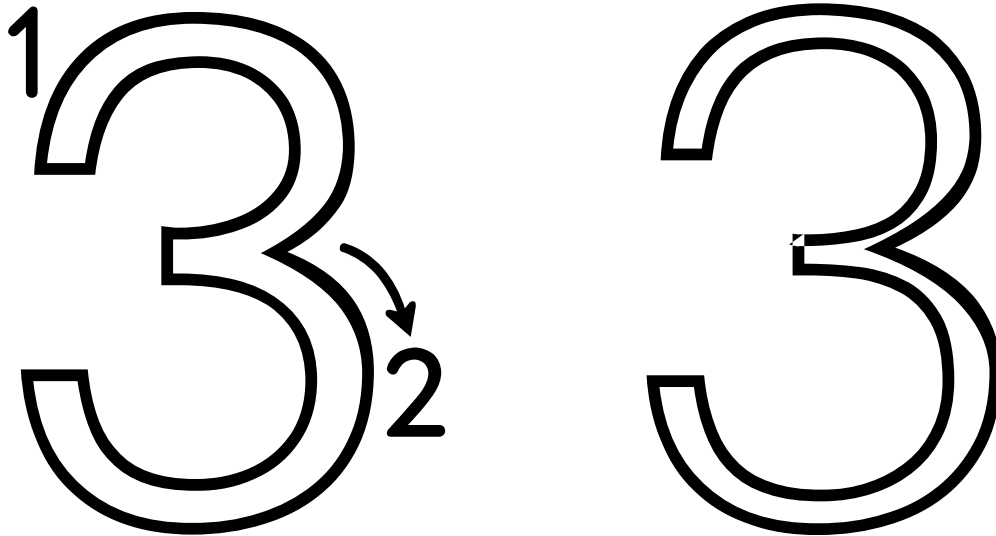

3	3	3	3	3	3	3	3
3	3						

3	3	3	3	3	3	3	3	3	3	3	3
3	3	3	3	3	3	3	3	3	3	3	3
3											
3											

Hier hat jemand die Dreien angeknabbert.
Repariere sie mit deinem Bleistift!

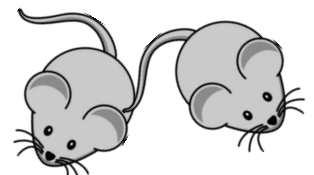



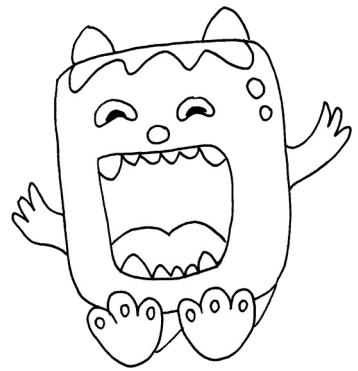
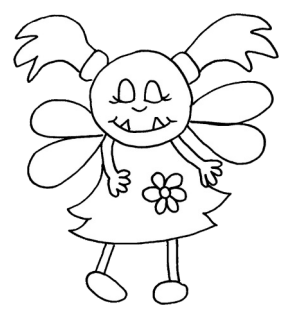
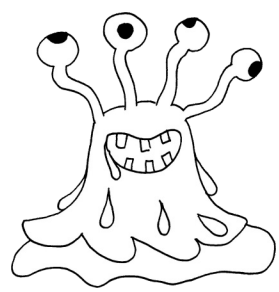
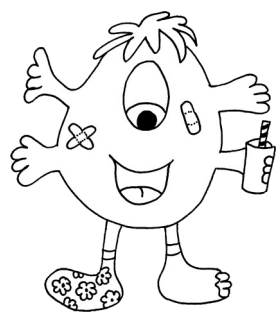
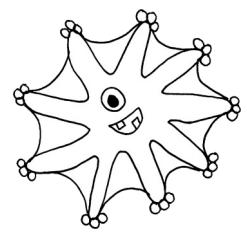
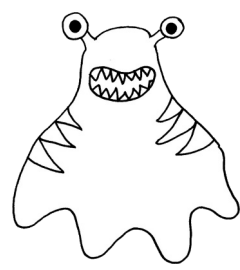
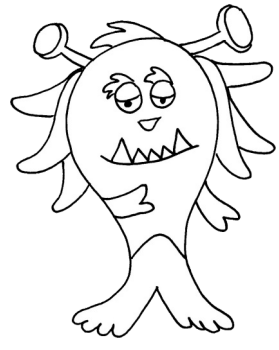
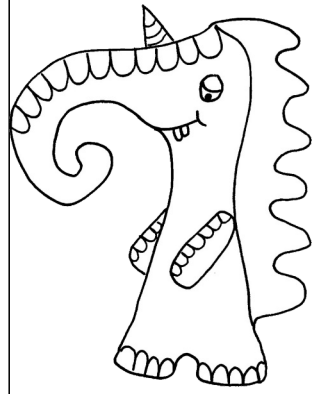
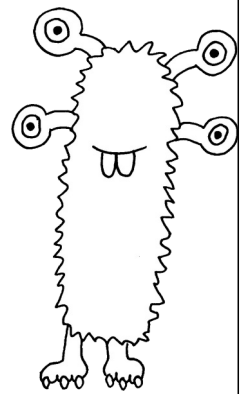
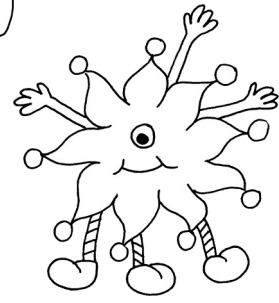
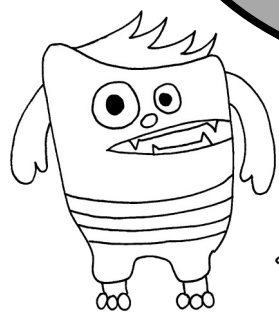
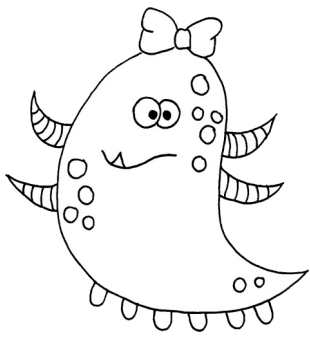
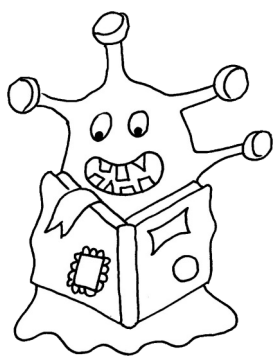
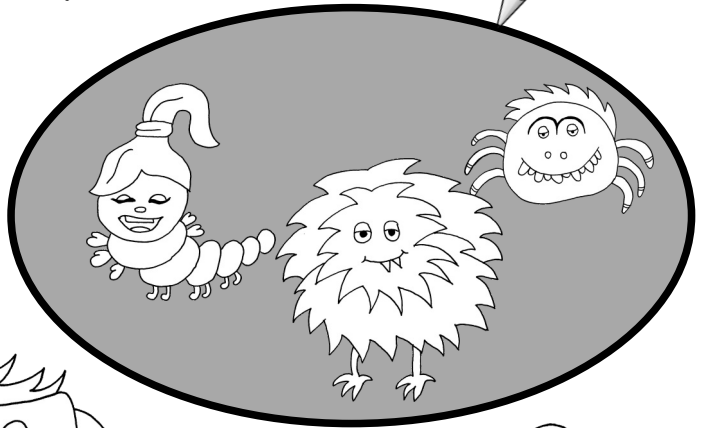

Immer 3

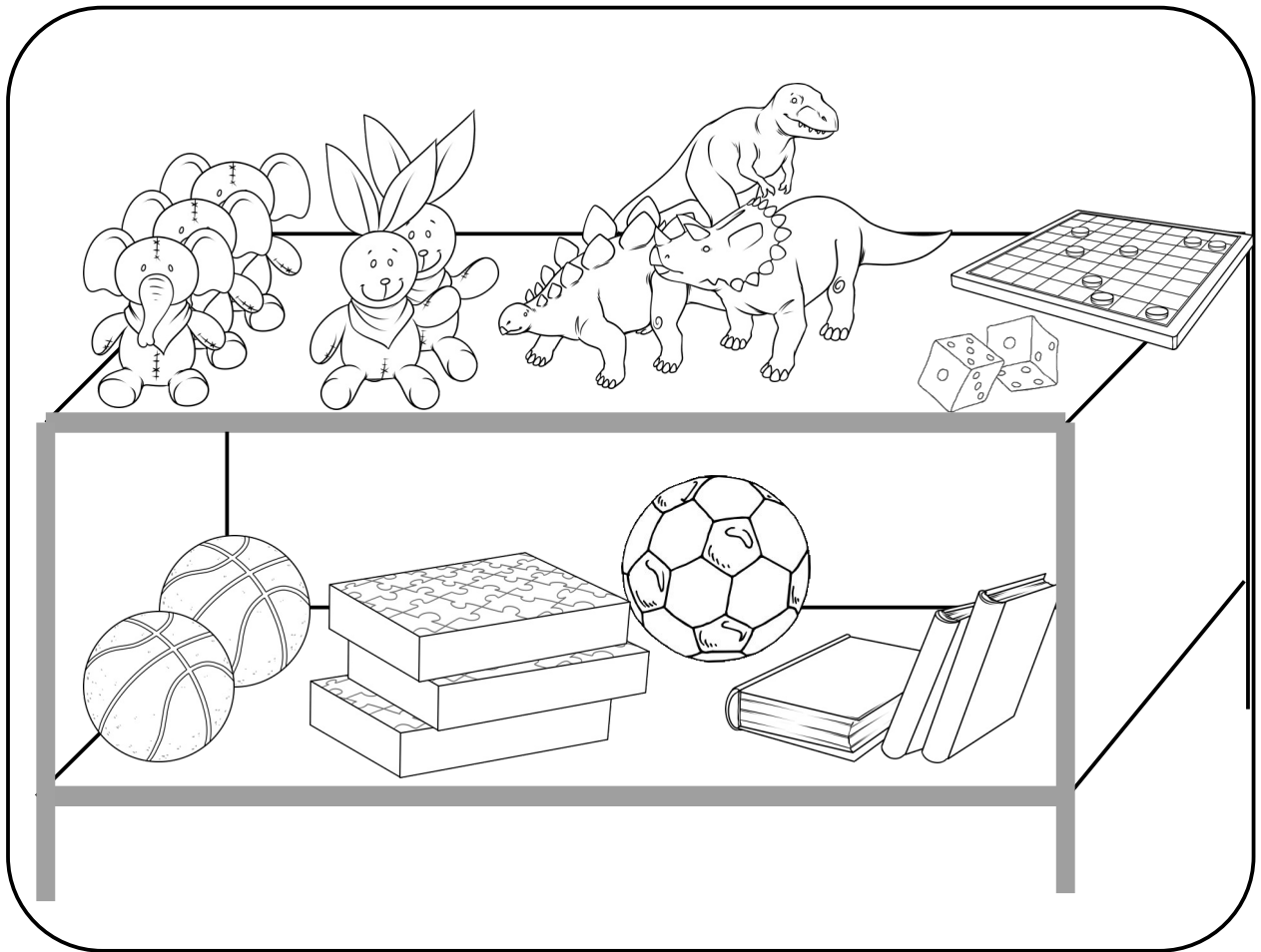

Kreise immer 3 Monster ein! Verwende für jeden Kreis eine andere Farbe!

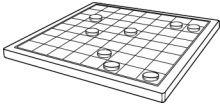
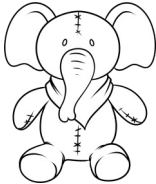
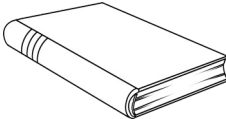

Zähle und schreibe die richtige Zahl in die Tabelle!

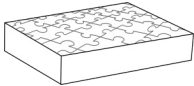
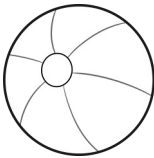
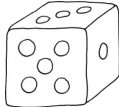

				 Dinos
1				

Gleich viele

Auf jedem Würfel siehst du Punkte. Male immer genau so viele Punkte in das Zehner-Feld daneben!

Illustration of a die showing 2 dots. To its right is a ten-frame with 2 dots filled in and a pencil pointing to the first dot. To the right of the ten-frame is a box containing the number 2, with a pencil pointing to it.

Illustration of a die showing 1 dot. To its right is an empty ten-frame and an empty box for writing the number.

Illustration of a die showing 0 dots. To its right is an empty ten-frame and an empty box for writing the number.

Illustration of a die showing 3 dots. To its right is an empty ten-frame and an empty box for writing the number.

Illustration of a die showing 1 dot. To its right is an empty ten-frame and an empty box for writing the number.

Illustration of a die showing 2 dots. To its right is an empty ten-frame and an empty box for writing the number.

Illustration of a die showing 3 dots. To its right is an empty ten-frame and an empty box for writing the number.

Stemple die passende Anzahl!

1



3

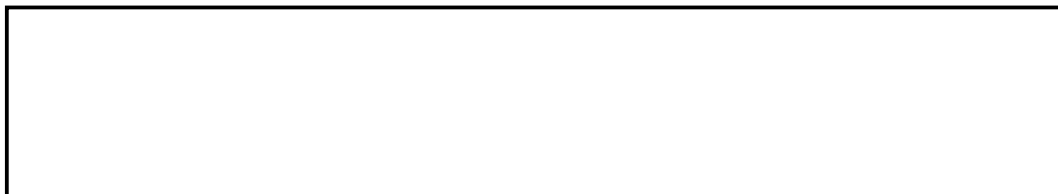

2



1

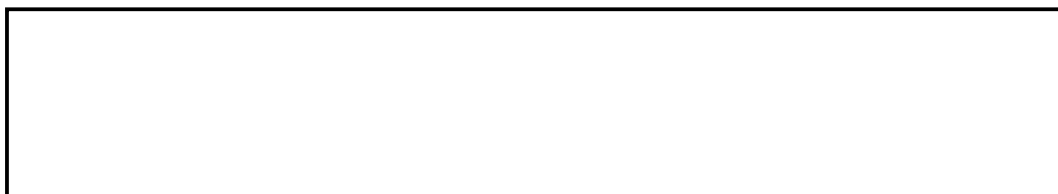

3



0



1



2



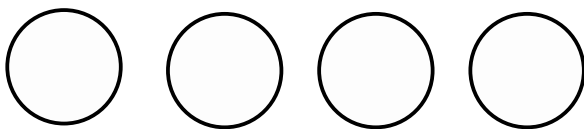
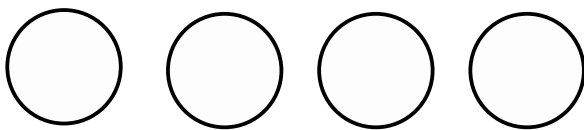
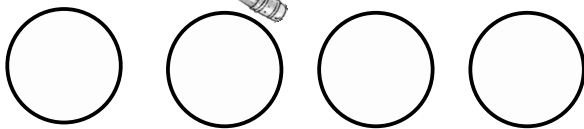
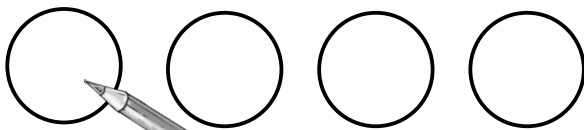
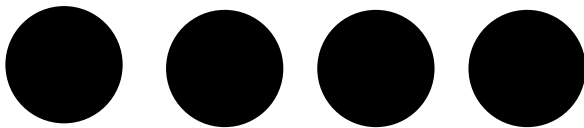
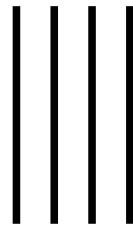
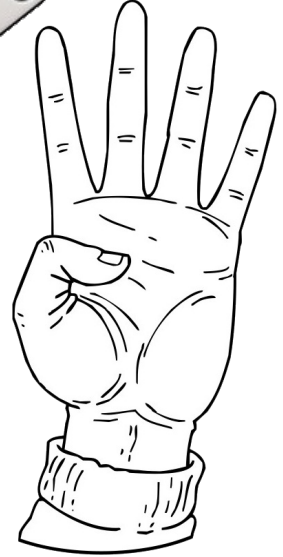
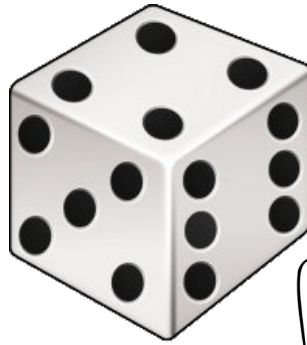
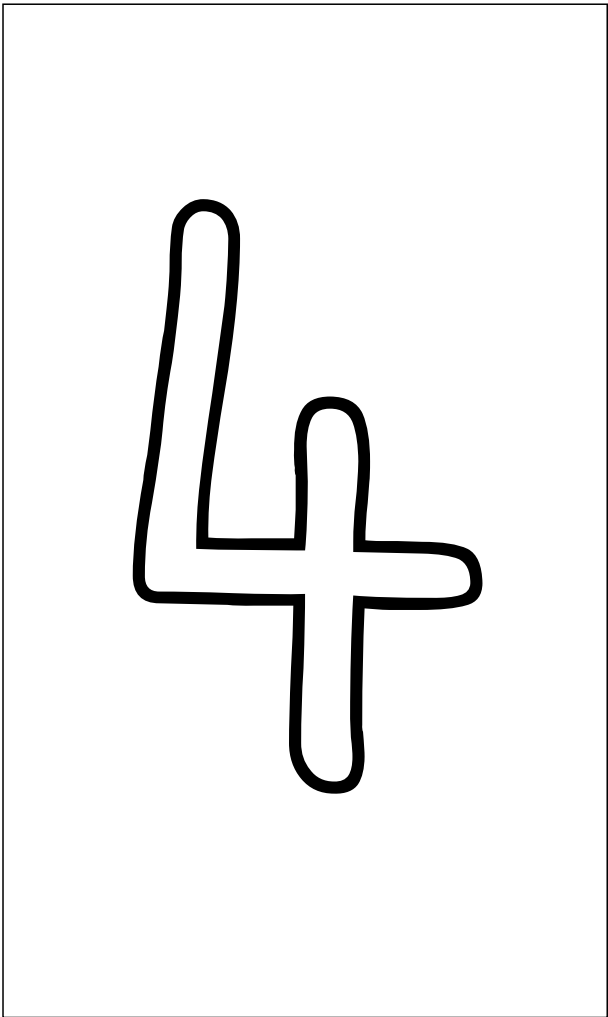

4	+	0
---	---	---

3	+	1
---	---	---

2	+	2
---	---	---

1	+	3
---	---	---

0	+	4
---	---	---

Die 4 schreiben

Spure zuerst die großen Vieren fünfmal mit verschiedenen Farben nach!
Schreibe dann die Zahlen, zuerst mit Hilfe der Punkte und dann ganz alleine!

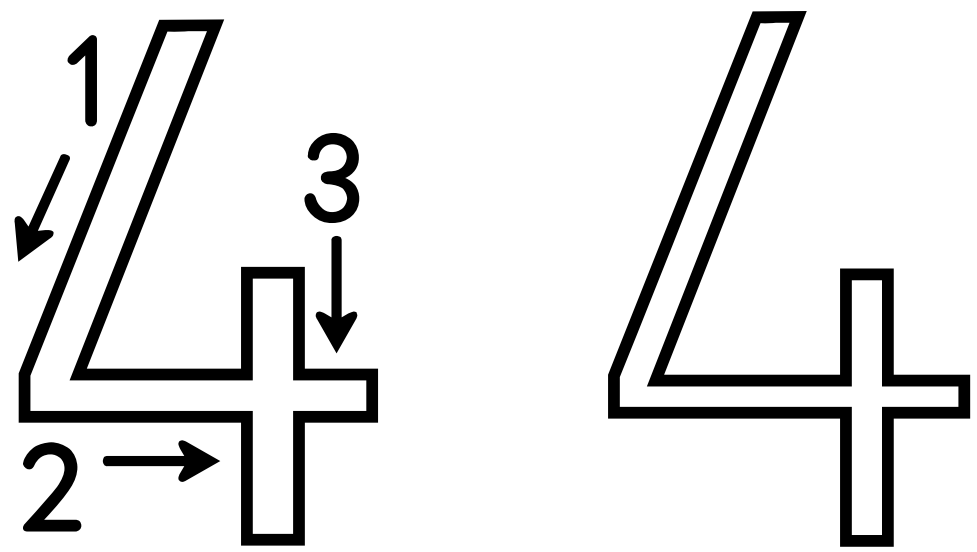

4	4	4	4	4	4	4	4
4	3	4	3				

4	4	4	4	4	4	4	4	4	4	4	4
4	4	4	4	4	4	4					
1	2	3	4	1	2						
4	3	4	3	4							

Hier hat jemand die Vieren angeknabbert.
Repariere sie mit deinem Bleistift!

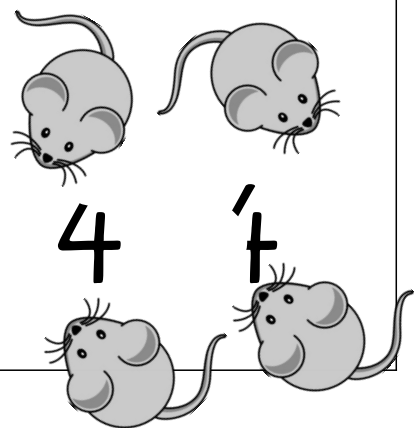



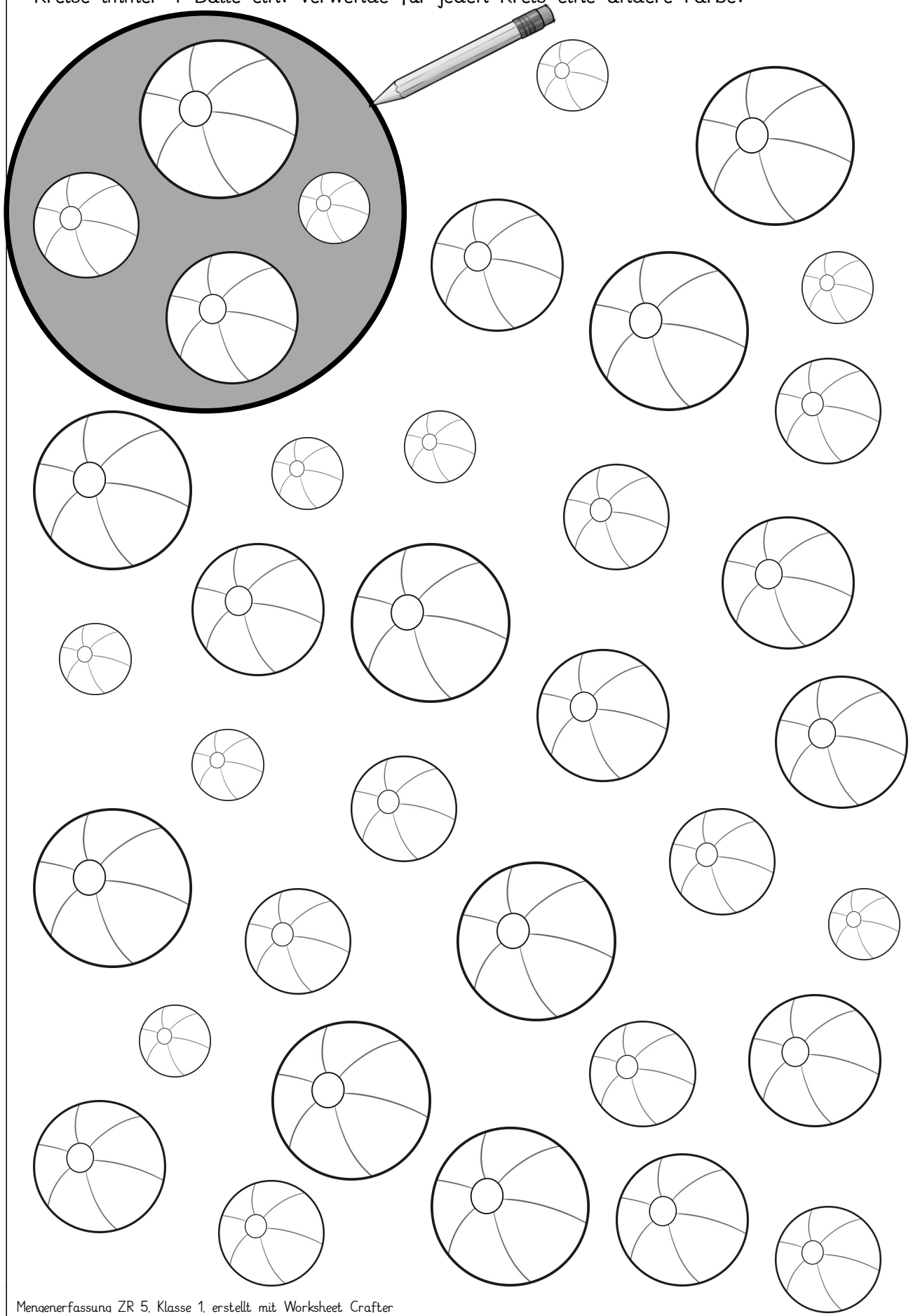

Immer 4



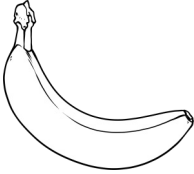

Kreise immer 4 Bälle ein! Verwende für jeden Kreis eine andere Farbe!

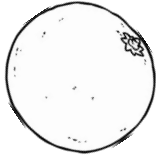
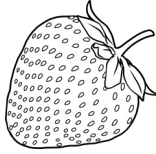

Zähle und schreibe die richtige Zahl in die Tabelle!



				
				1

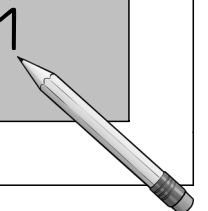

Gleich viele

Auf jedem Würfel siehst du Punkte. Male immer genau so viele Punkte in das Zehner-Feld daneben!

Illustration of a die face with 2 dots, a ten-frame with 2 filled circles, and a box containing the number 2. A pencil is shown coloring the circles and writing the number.

Illustration of a die face with 1 dot, a ten-frame with 10 empty circles, and an empty box for the number.

Illustration of a die face with 3 dots, a ten-frame with 10 empty circles, and an empty box for the number.

Illustration of a die face with 4 dots, a ten-frame with 10 empty circles, and an empty box for the number.

Illustration of a die face with 0 dots, a ten-frame with 10 empty circles, and an empty box for the number.

Illustration of a die face with 2 dots, a ten-frame with 10 empty circles, and an empty box for the number.

Illustration of a die face with 4 dots, a ten-frame with 10 empty circles, and an empty box for the number.

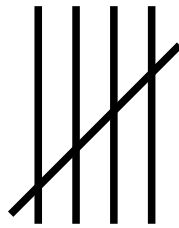
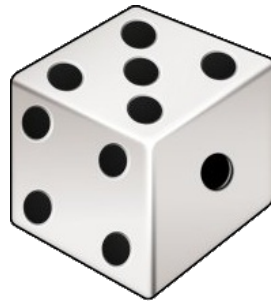
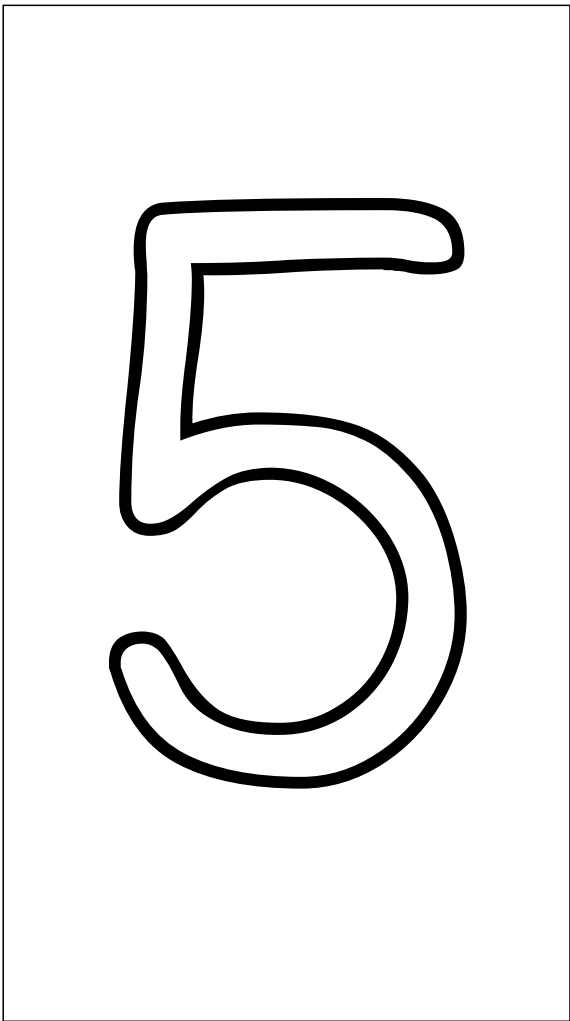

A dot marker activity consisting of a 6x5 grid of circles. The top row contains five solid black circles. The remaining five rows contain five empty circles each. A pencil is positioned over the second circle in the second row.

5	+	0
4	+	1
3	+	2
2	+	3
1	+	2
0	+	3

Die 5 schreiben

Spure zuerst die großen Fünfen fünfmal mit verschiedenen Farben nach!
Schreibe dann die Zahlen, zuerst mit Hilfe der Punkte und dann ganz alleine!

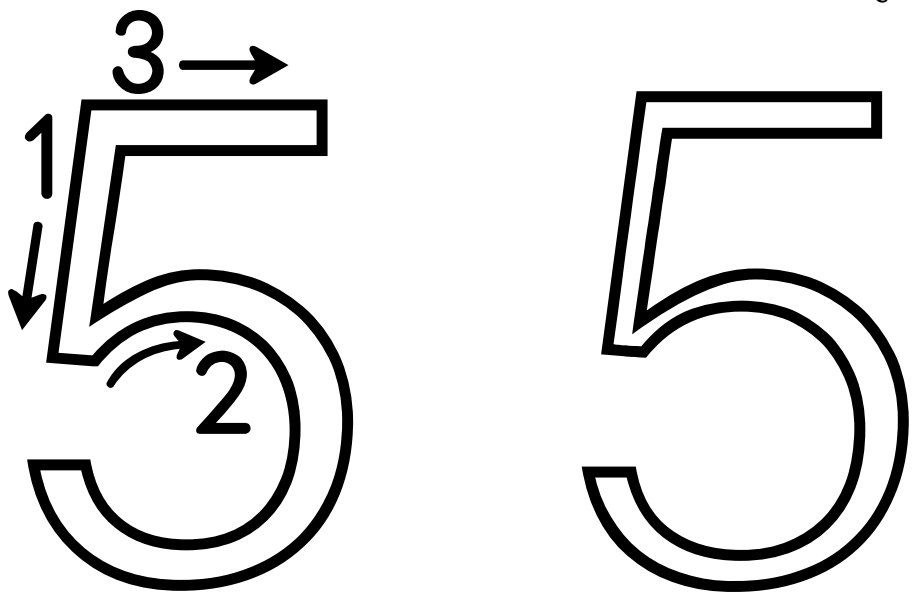

5	5	5	5	5	5	5	5
5	4	3	5				

5	5	5	5	5	5	5	5	5	5	5	5
5	5	5	5	5	5	5					
1	2	3	4	5	1						
5	4	5	4	5							

Hier hat jemand die Fünfen angeknabbert.
Repariere sie mit deinem Bleistift!

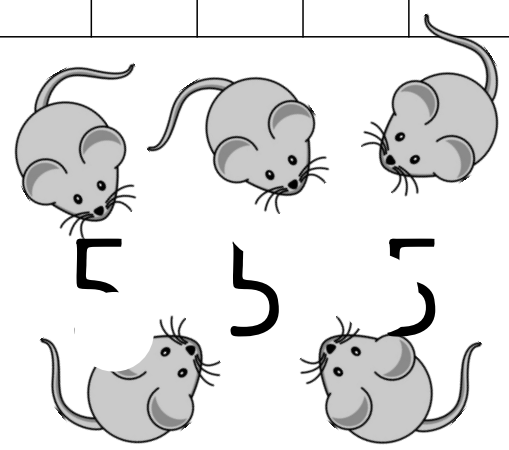
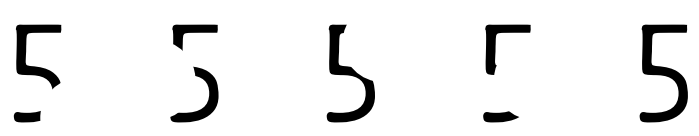





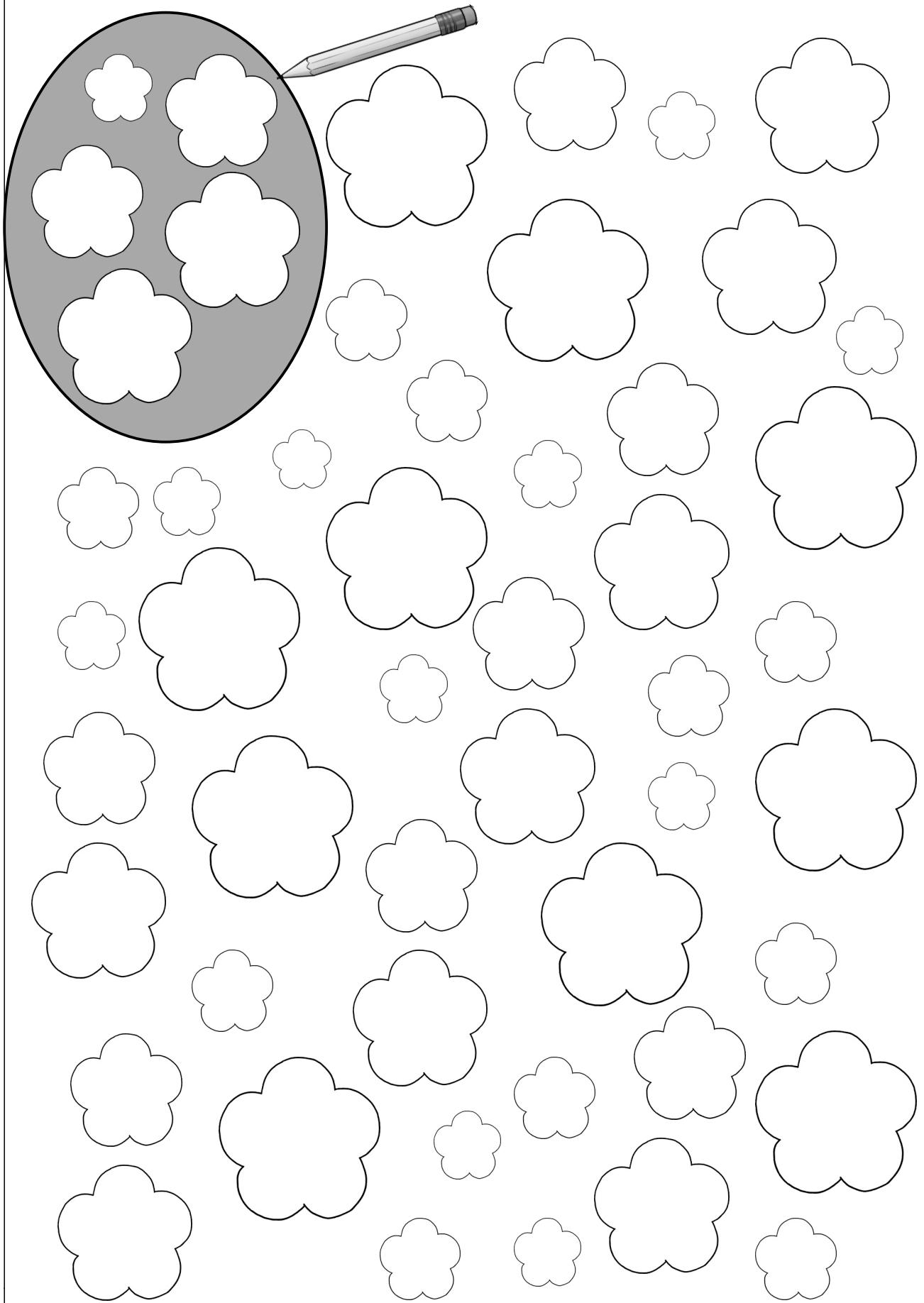

Immer 5





Kreise immer 5 Blumen ein! Verwende für jeden Kreis eine andere Farbe!



Zähle und schreibe die richtige Zahl in die Tabelle!



				
			1 	

Gleich viele

Auf jedem Würfel siehst du Punkte. Male immer genau so viele Punkte in das Zehner-Feld daneben!

A dice showing 2 dots. To its right is a ten-frame with 10 circles; the first two are filled with black dots, and the rest are empty. A pencil is pointing to the second dot. To the right of the ten-frame is a box containing the number 2, with a pencil pointing to it.

A dice showing 5 dots. To its right is a ten-frame with 10 empty circles. To the right of the ten-frame is an empty box.

A dice showing 1 dot. To its right is a ten-frame with 10 empty circles. To the right of the ten-frame is an empty box.

A dice showing 4 dots. To its right is a ten-frame with 10 empty circles. To the right of the ten-frame is an empty box.

A dice showing 3 dots. To its right is a ten-frame with 10 empty circles. To the right of the ten-frame is an empty box.

A dice showing 2 dots. To its right is a ten-frame with 10 empty circles. To the right of the ten-frame is an empty box.

A dice showing 1 dot. To its right is a ten-frame with 10 empty circles. To the right of the ten-frame is an empty box.

Immer einer mehr

Im linken Zehner-Feld siehst du eine Anzahl Punkte. Zähle sie und schreibe die Zahl.
Im Zehner-Feld daneben sollst du einen Punkt mehr malen. Wie heißt diese Zahl?

	<input type="text" value="3"/>	<	<input type="text" value="4"/>	
--	--------------------------------	---	--------------------------------	--

	<input type="text"/>	<	<input type="text"/>	
--	----------------------	---	----------------------	--

	<input type="text"/>	<	<input type="text"/>	
--	----------------------	---	----------------------	--

	<input type="text"/>	<	<input type="text"/>	
--	----------------------	---	----------------------	--

	<input type="text"/>	<	<input type="text"/>	
--	----------------------	---	----------------------	--

	<input type="text"/>	<	<input type="text"/>	
--	----------------------	---	----------------------	--

	<input type="text"/>	<	<input type="text"/>	
--	----------------------	---	----------------------	--

	<input type="text"/>	<	<input type="text"/>	
--	----------------------	---	----------------------	--

	<input type="text"/>	<	<input type="text"/>	
--	----------------------	---	----------------------	--

Was gehört zusammen?

Verbinde die Bilder mit der passenden Zahl!

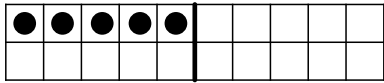

1

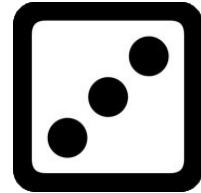

3

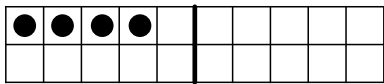
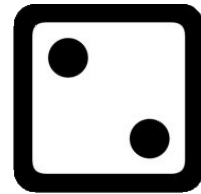

4



5

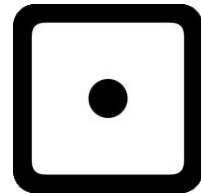

2



Stemple die passende Anzahl!

2



5



3



1



4



3



0



5



Tiere füttern

Jedes Tier braucht Futter. Es sagt dir, wie viele es haben möchte. Male die richtige Menge aus!

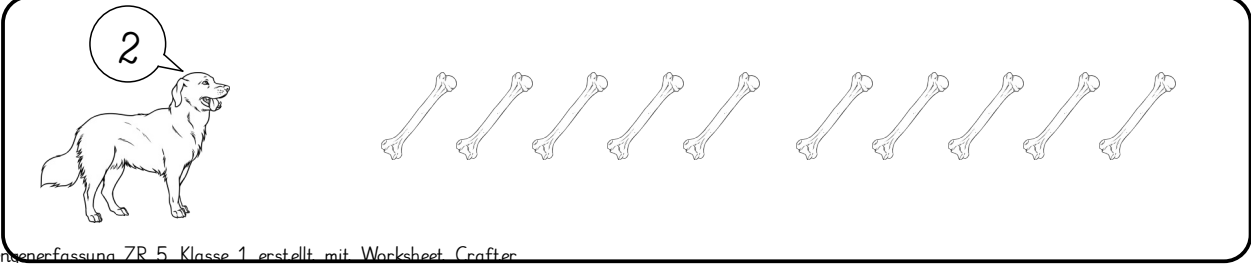
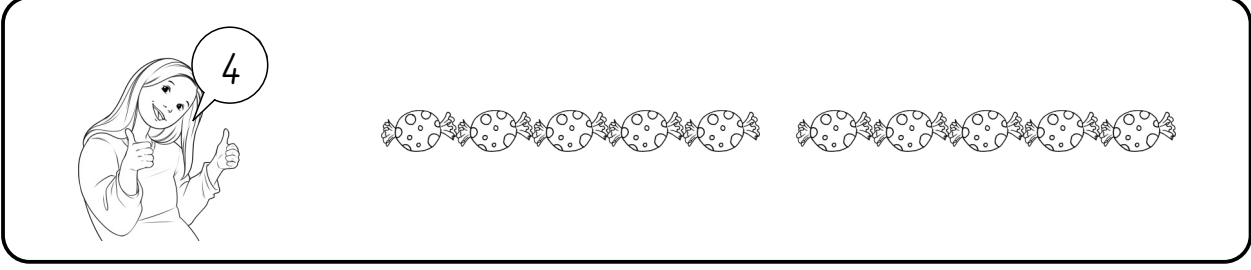
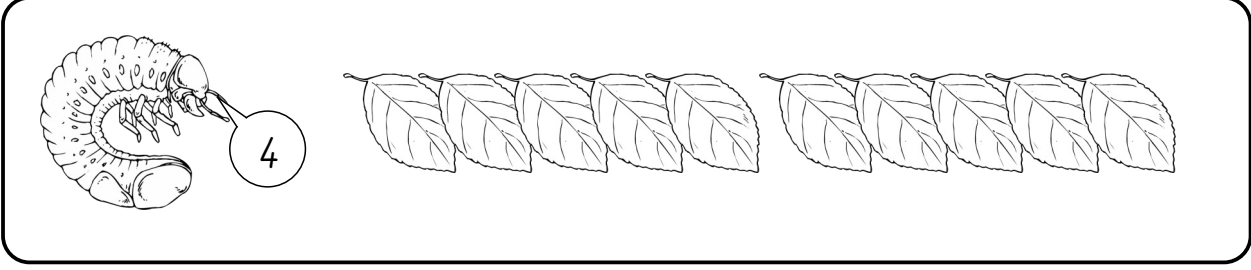
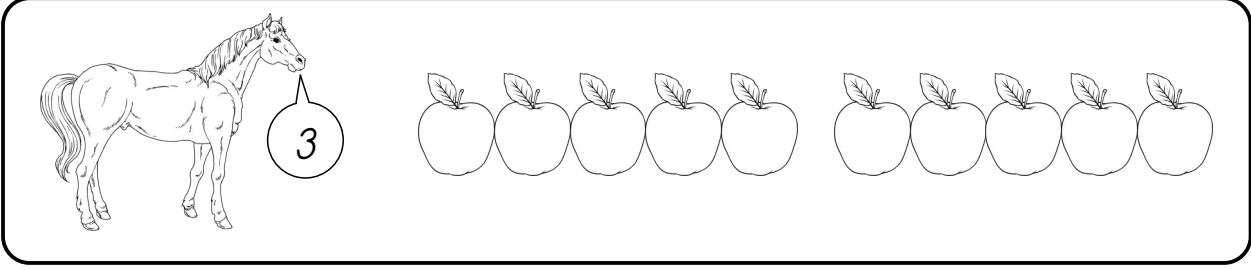
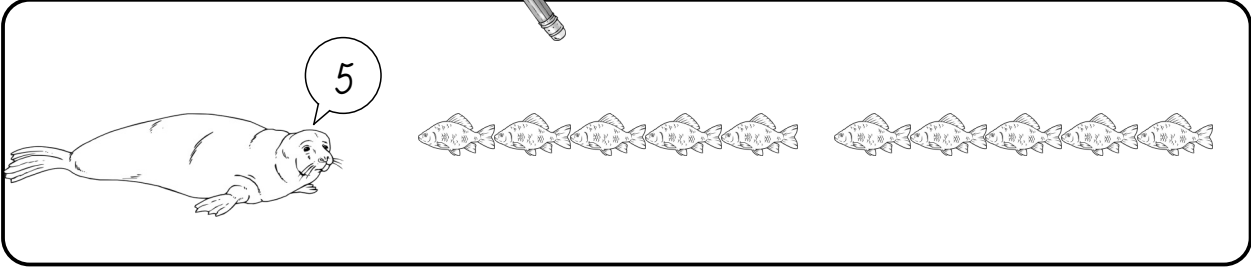
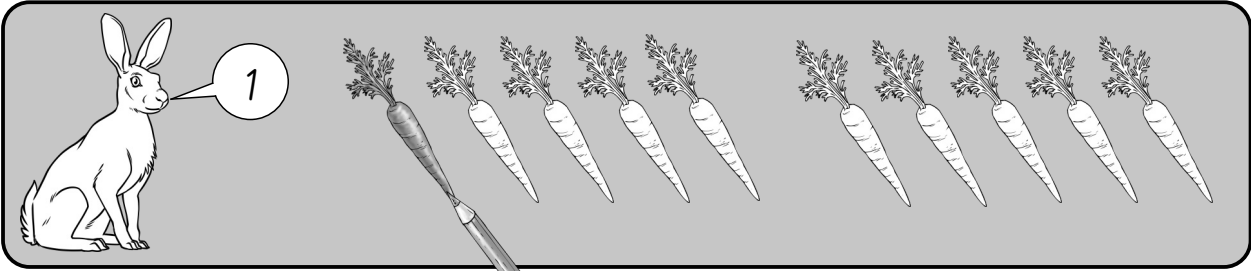

Klebe oder male die fehlenden Punkte!

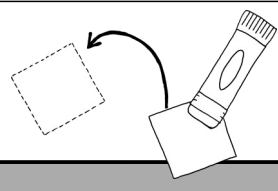

2



1



3



4

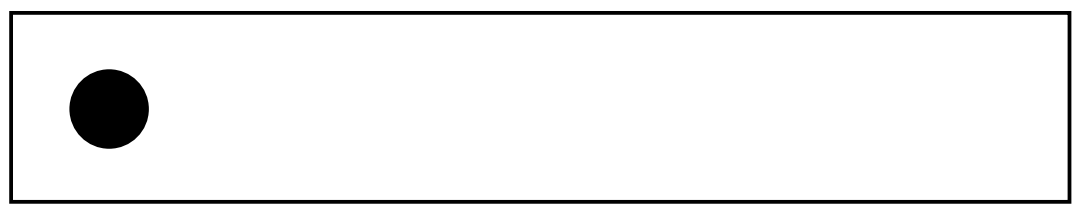

5



4



3



5



Immer einer weniger

Im linken Zehner-Feld siehst du eine Anzahl Punkte. Zähle sie und schreibe die Zahl.
Im Zehner-Feld daneben sollst du einen Punkt weniger malen. Wie heißt diese Zahl?

	3	>	2	
--	---	---	---	--

		>		
--	--	---	--	--

		>		
--	--	---	--	--

		>		
--	--	---	--	--

		>		
--	--	---	--	--

		>		
--	--	---	--	--

		>		
--	--	---	--	--

		>		
--	--	---	--	--

		>		
--	--	---	--	--

Klebe oder male die fehlenden Punkte!

30

5

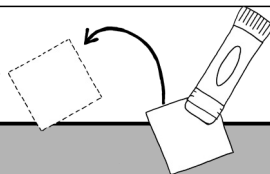

3



2



1



4



3



5



4

